



# AURA

## FIRES

Built Ins  
Product Specification  
Kinver Range

Model	A	B	C	D	E
Kinver 850 SL	853 mm	885 mm	413 mm	225 mm	587 mm
Kinver 1000 SL	1003 mm	1035 mm	413 mm	225 mm	587 mm
Kinver 1250 SL	1255 mm	1285 mm	415 mm	225 mm	587 mm
Kinver 1500 SL	1506 mm	1535 mm	415 mm	225 mm	587mm
Kinver 1800 SL	1755 mm	1785 mm	415 mm	225 mm	587 mm

### Sizing Chart

A - Width excl. plaster kit  
 B - Width inc. plaster kit  
 C - Opening height  
 D - Depth excl. plaster kit  
 E - Height

### Converting to GF / GF2 / GF3

The appliance is shipped in the GF3 configuration, however all models can be converted to be GF or GF2 depending on your preference.



2 Year Warranty



Variable thermostat



Remote control



On / Off



LED



E Smart App



Dimmer



Heat on



Heat off



Log fuel bed



Alexa & Google Assistant

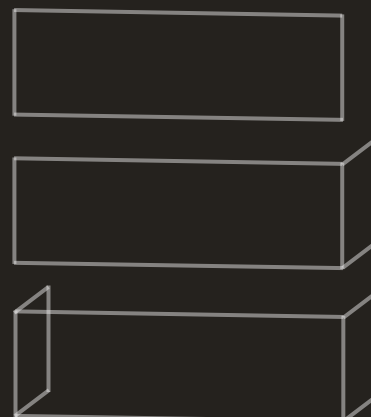

The Built In range is supplied with the British Woodland Real Loose Logs





**Product Specification**

Built In Electric    Kinver 850 SL  
(M850x225)

Height A    587 mm

Width B    885 mm

Depth C    241 mm

Code | Colour    AUBIKINV850BLK

Available with 3 glass types

2 Year Warranty

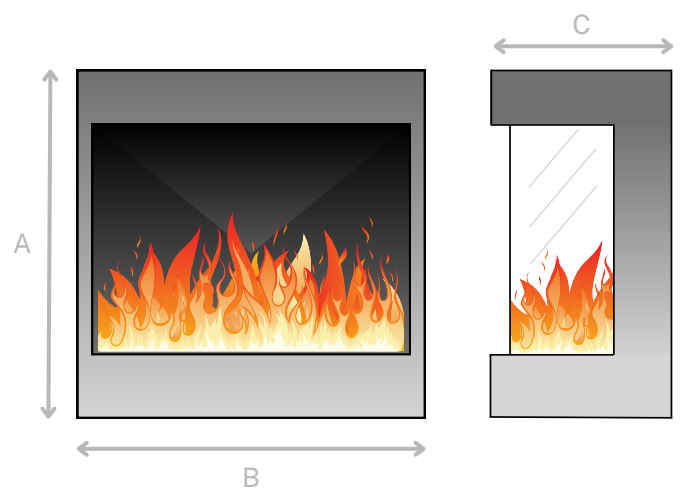

Product Specification

Flame Effect Electra

Flame Colour 11 flame colours

Log Set British Woodland

Engine Flame Electra

Fuel Type Electric

Controls Remote

E-Smart Yes

App Technology Yes

Heat Output 1500w

Heat Settings Variable

Variable Thermostat Yes

Lamp Style LED

Power Cord 1.8m Kettle

Safety Cut Out Yes

Core Material Steel | Metal

Accessories

Product Specification

Launch Date July 2024

Brand Aura

Product Category Built In

Model Kinver 850 SL

Country of Origin China

UKCA Yes

NICA Yes

CE (Europe) Yes

LOT 20 Yes

WEEE Yes

Packaging

Box Height 740 mm

Box Width 1120 mm

Box Depth 360 mm

Pallet Width Unique pallet

Pallet Depth Unique pallet

Units per Pallet 1 (Purpose built pallet)

Weight 35Kg

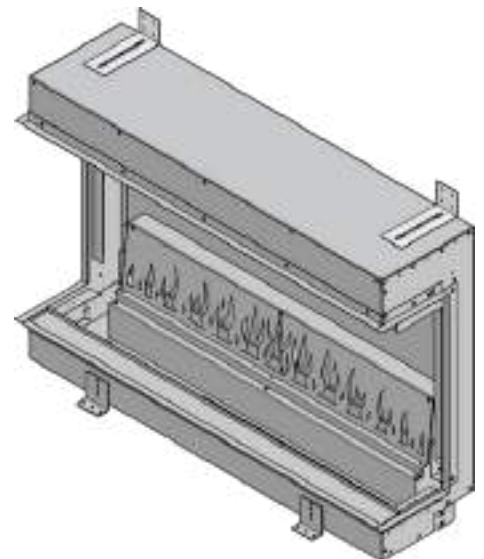
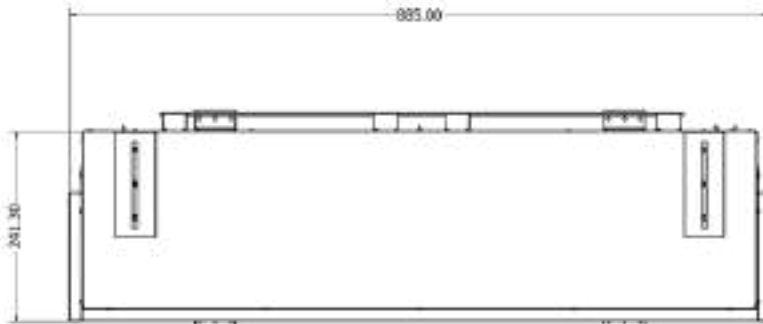
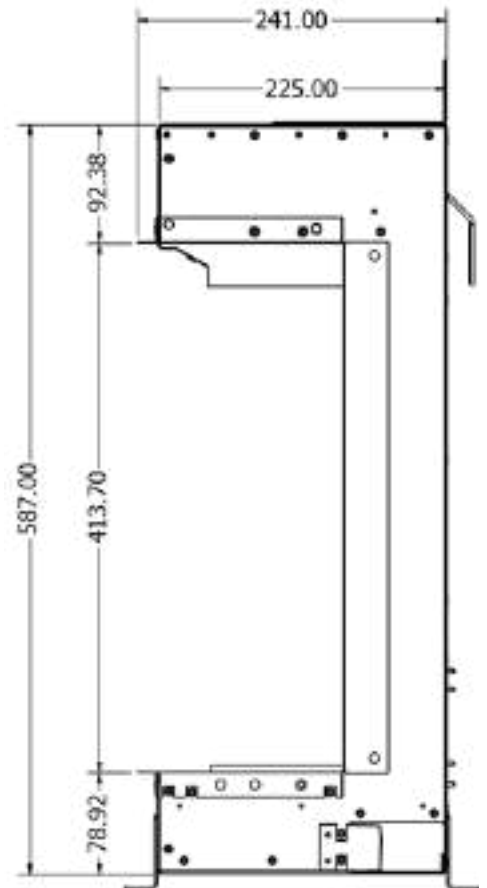
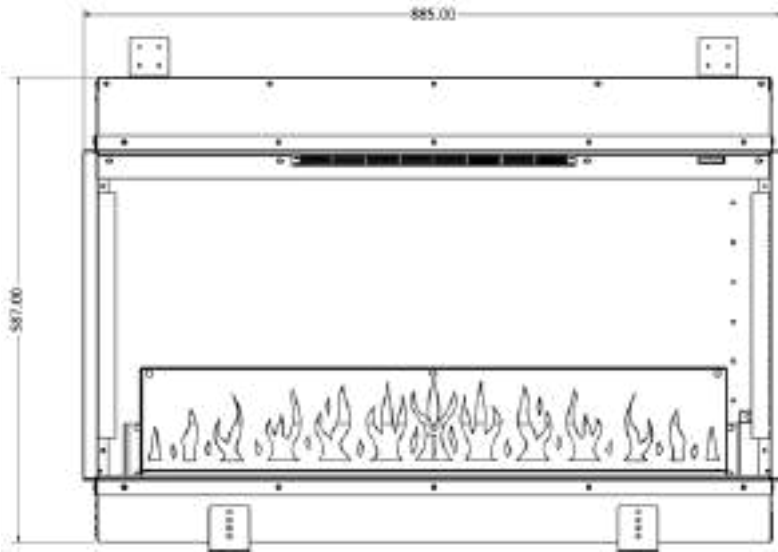



**Product Specification**

Built Electric Kinver 1000 SL (S1000x225)

Height A 586 mm

Width B 1035 mm

Depth C 241 mm

Code | Colour AUBIKIN1000BLK

Available with 3 glass types

2 Year Warranty

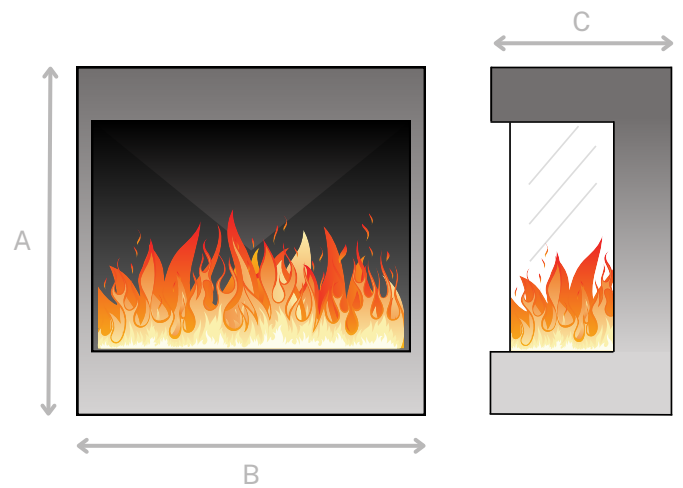

Product Specification

Flame Effect    Electra

Flame Colour    11 flame colours

Log Set    British Woodland

Engine Flame    Electra

Fuel Type    Electric

Controls    Remote

E-Smart    Yes

App Technology    Yes

Heat Output    1500w

Heat Settings    Variable

Variable Thermostat    Yes

Lamp Style    LED

Power Cord    1.8m Kettle

Safety Cut Out    Yes

Core Material    Steel | Metal

Accessories

Product Specification

Launch Date    July 2024

Brand    Aura

Product Category    Built In

Model    Kinver 1000 SL

Country of Origin    China

UKCA    Yes

NICA    Yes

CE (Europe)    Yes

LOT 20    Yes

WEEE    Yes

Packaging

Box Height    730 mm

Box Width    1300 mm

Box Depth    400 mm

Pallet Width    Unique pallet

Pallet Depth    Unique Pallet

Units per Pallet    1 (Purpose built pallet)

Weight    45kg

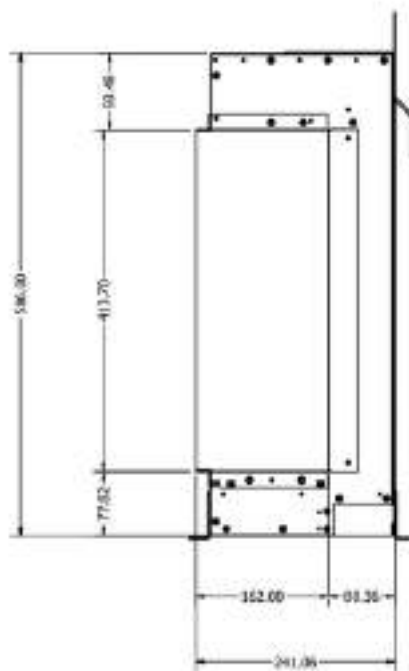
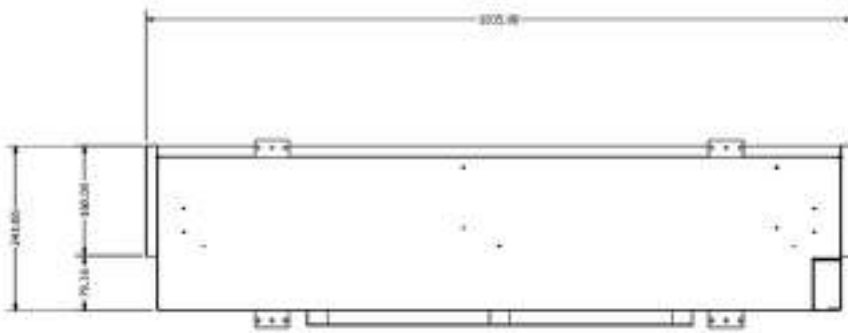
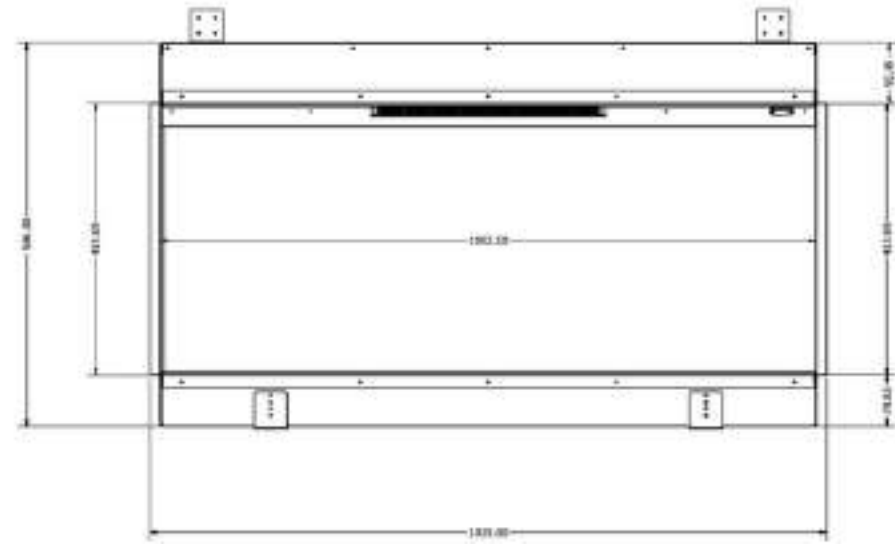



**Product Specification**

Built In Electric    Kinver 1250 SL  
(M1250x225)

Height A    587 mm

Width B    1285 mm

Depth C    225 mm

Code | Colour    AUBIKIN1250BLK

Available with 3 glass types

2 Year Warranty

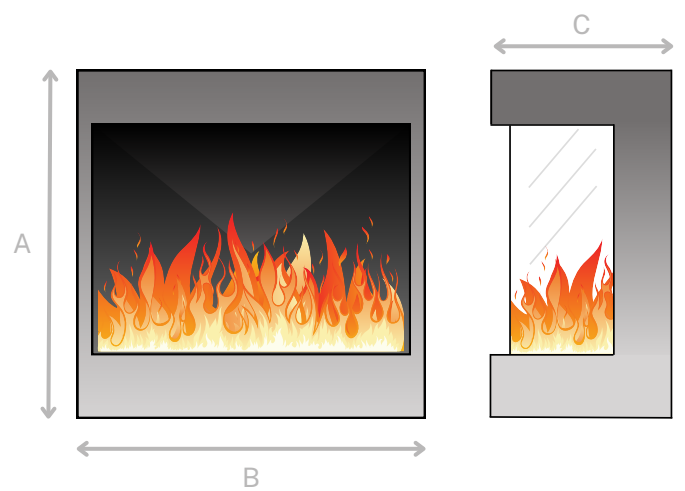

Product Specification

Flame Effect Electra

Flame Colour 11 flame colours

Log Set British Woodland

Engine Flame Electra

Fuel Type Electric

Controls Remote

E-Smart Yes

App Technology Yes

Heat Output 1500w

Heat Settings Variable

Variable Thermostat Yes

Lamp Style LED

Power Cord 1.8m Kettle

Safety Cut Out Yes

Core Material Steel | Metal

Accessories

Product Specification

Launch Date July 2024

Brand Aura

Product Category Built In

Model Kinver 1250 SL

Country of Origin China

UKCA Yes

NICA Yes

CE (Europe) Yes

LOT 20 Yes

WEEE Yes

Packaging

Box Height 730 mm

Box Width 1550 mm

Box Depth 400 mm

Pallet Width Unique pallet

Pallet Depth Unique Pallet

Units per Pallet 1 (Purpose built pallet)

Weight 55kg

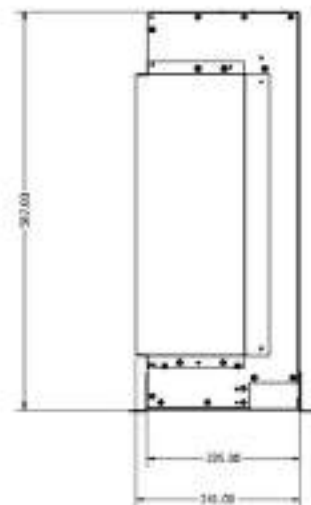
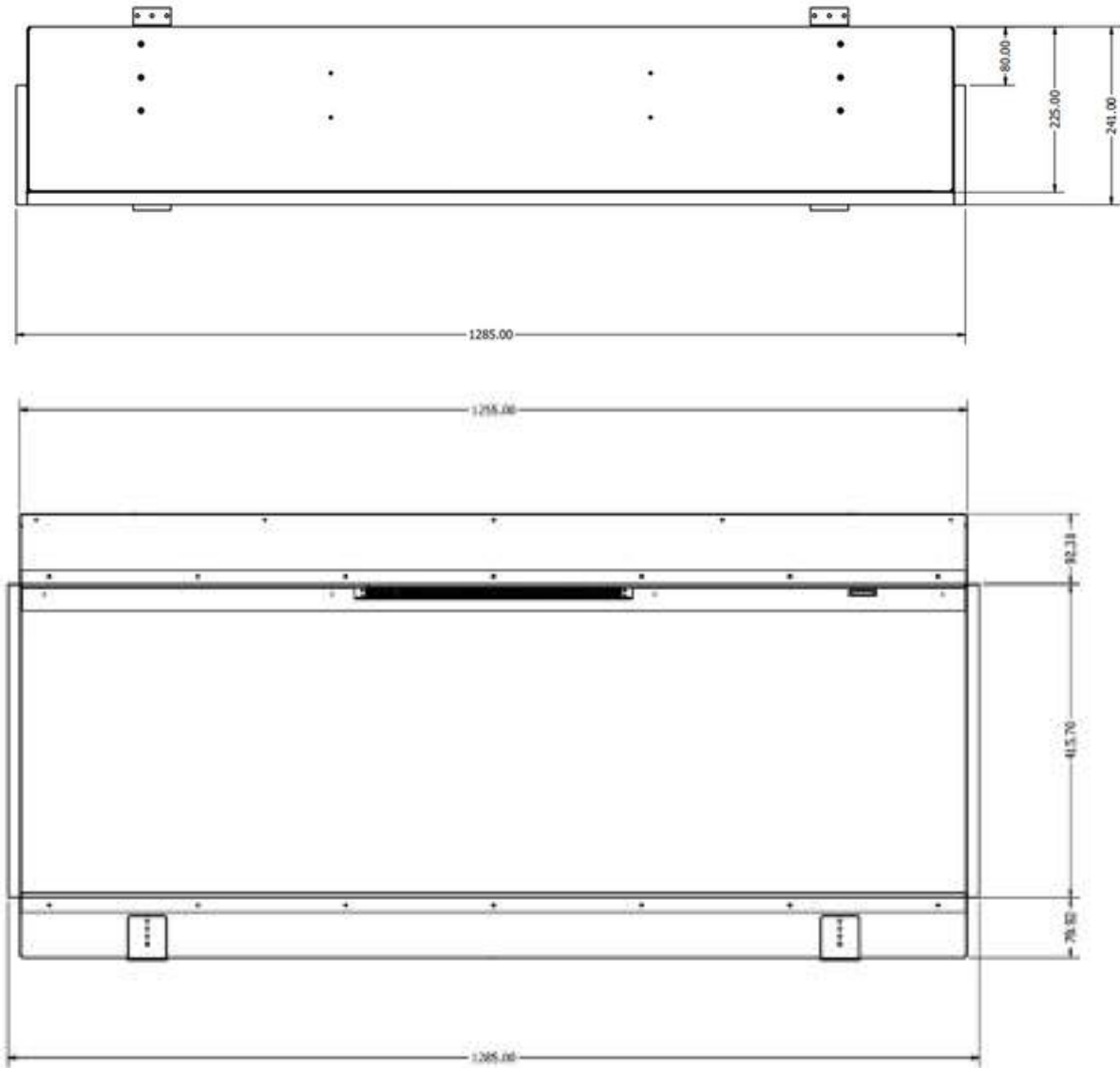



**Product Specification**

Built In Electric Kinver 1500 SL  
(M1500x225)

Height A 587 mm

Width B 1535 mm

Depth C 241 mm

Code | Colour AUBIKIN1500BLK

Available with 3 glass types

2 Year Warranty

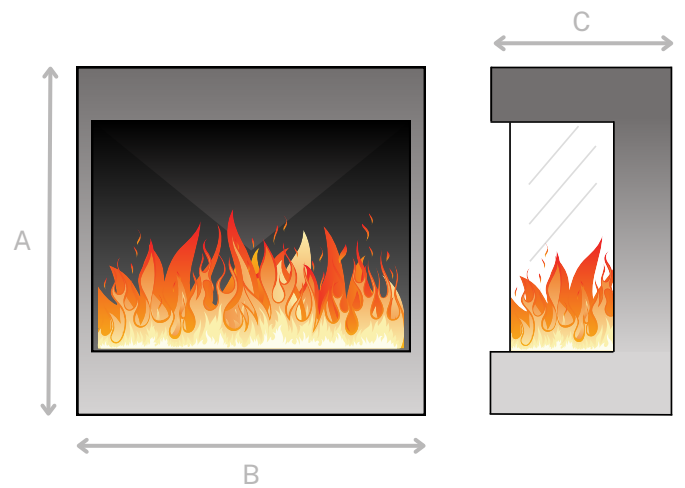

Product Specification

Flame Effect Electra

Flame Colour 11 flame colours

Log Set British Woodland

Engine Flame Electra

Fuel Type Electric

Controls Remote

E-Smart Yes

App Technology Yes

Heat Output 1.5Kw

Heat Settings 0.75Kw & 1.5Kw

Variable Thermostat Yes

Lamp Style LED

Power Cord 1.8m Kettle

Safety Cut Out Yes

Core Material Steel | Metal

Accessories

Product Specification

Launch Date July 2024

Brand Aura

Product Category Built In

Model Kinver 1500 SL

Country of Origin China

UKCA Yes

NICA Yes

CE (Europe) Yes

LOT 20 Yes

WEEE Yes

Packaging

Box Height 720 mm

Box Width 1790 mm

Box Depth 400 mm

Pallet Width Unique pallet

Pallet Depth Unique Pallet

Units per Pallet 1 (Purpose built pallet)

Weight 58kg

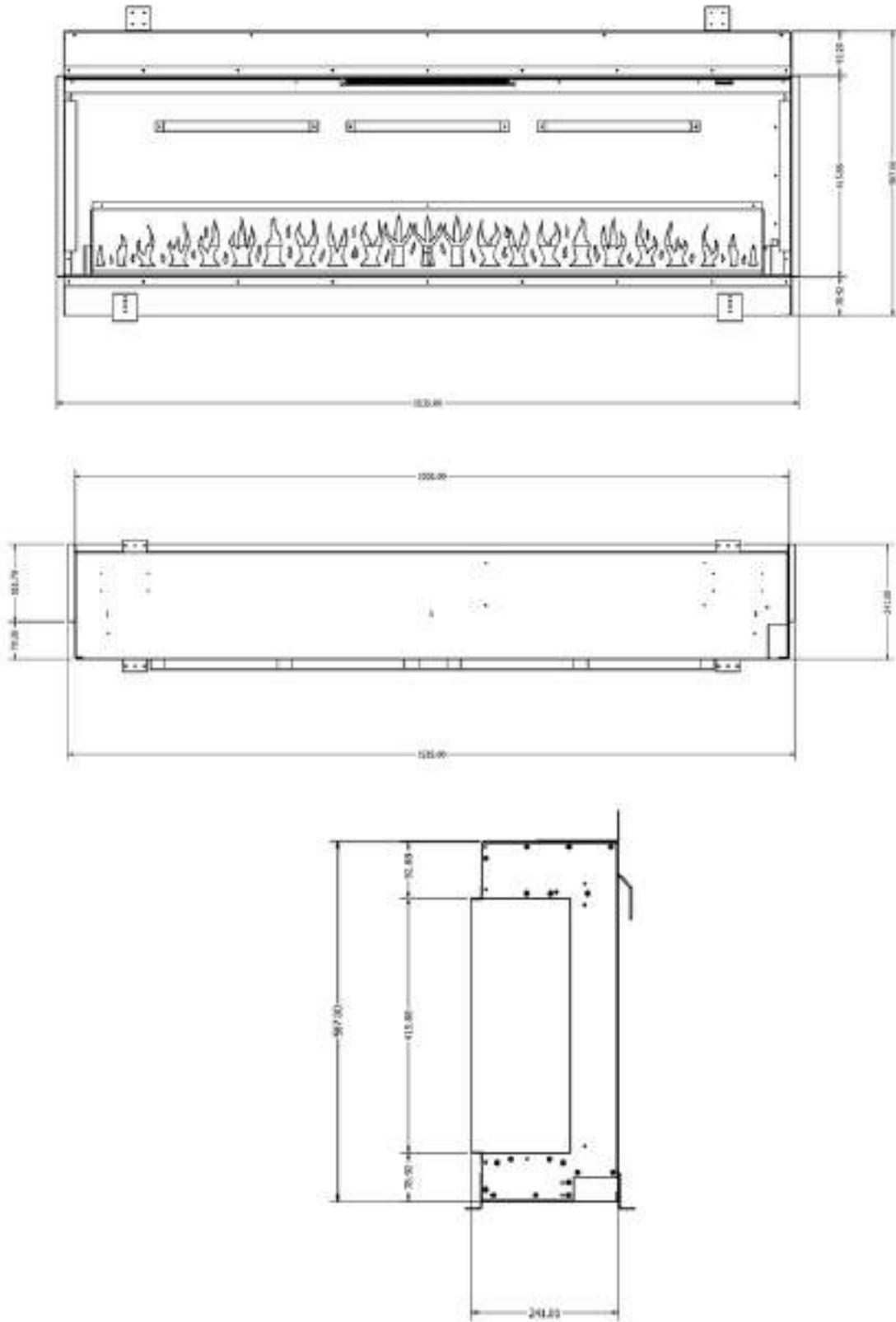



**Product Specification**

Built In Electric Kinver 1800 SL (M1800x225)

Height A 587mm

Width B 1785mm

Depth C 225mm

Code | Colour AUBIKIN1800BLK

Available with 3 glass types

2 Year Warranty

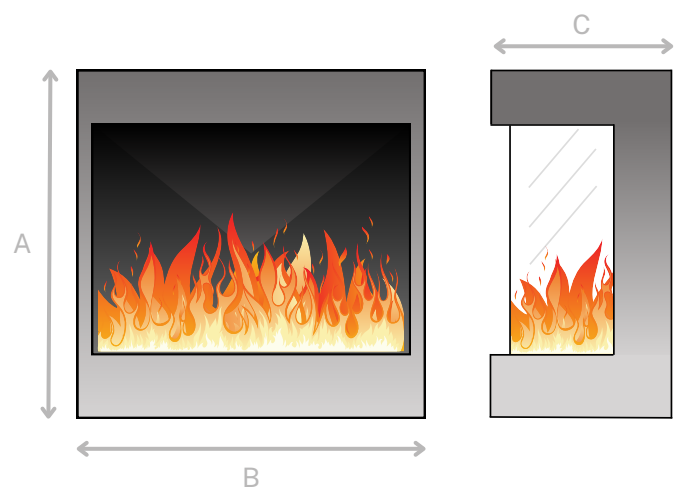

Product Specification

Flame Effect    Electra

Flame Colour    11 flame colours

Log Set    British Woodland

Engine Flame    Electra

Fuel Type    Electric

Controls    Remote

E-Smart    Yes

App Technology    Yes

Heat Output    1500w

Heat Settings    Variable

Variable Thermostat    Yes

Lamp Style    LED

Power Cord    1.8m Kettle

Safety Cut Out    Yes

Core Material    Steel | Metal

Accessories

Product Specification

Launch Date    July 2024

Brand    Aura

Product Category    Built In

Model    Kinver 1800 SL

Country of Origin    China

UKCA    Yes

NICA    Yes

CE (Europe)    Yes

LOT 20    Yes

WEEE    Yes

Packaging

Box Height    730 mm

Box Width    2050 mm

Box Depth    400 mm

Pallet Width    Unique pallet

Pallet Depth    Unique Pallet

Units per Pallet    1 (Purpose built pallet)

Weight    70kg

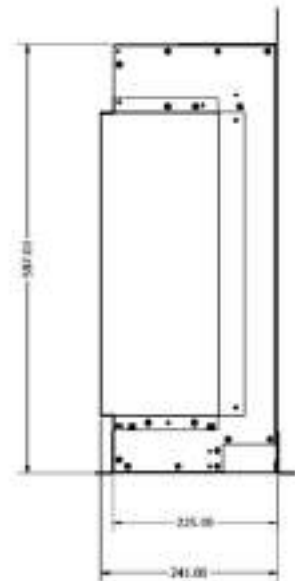
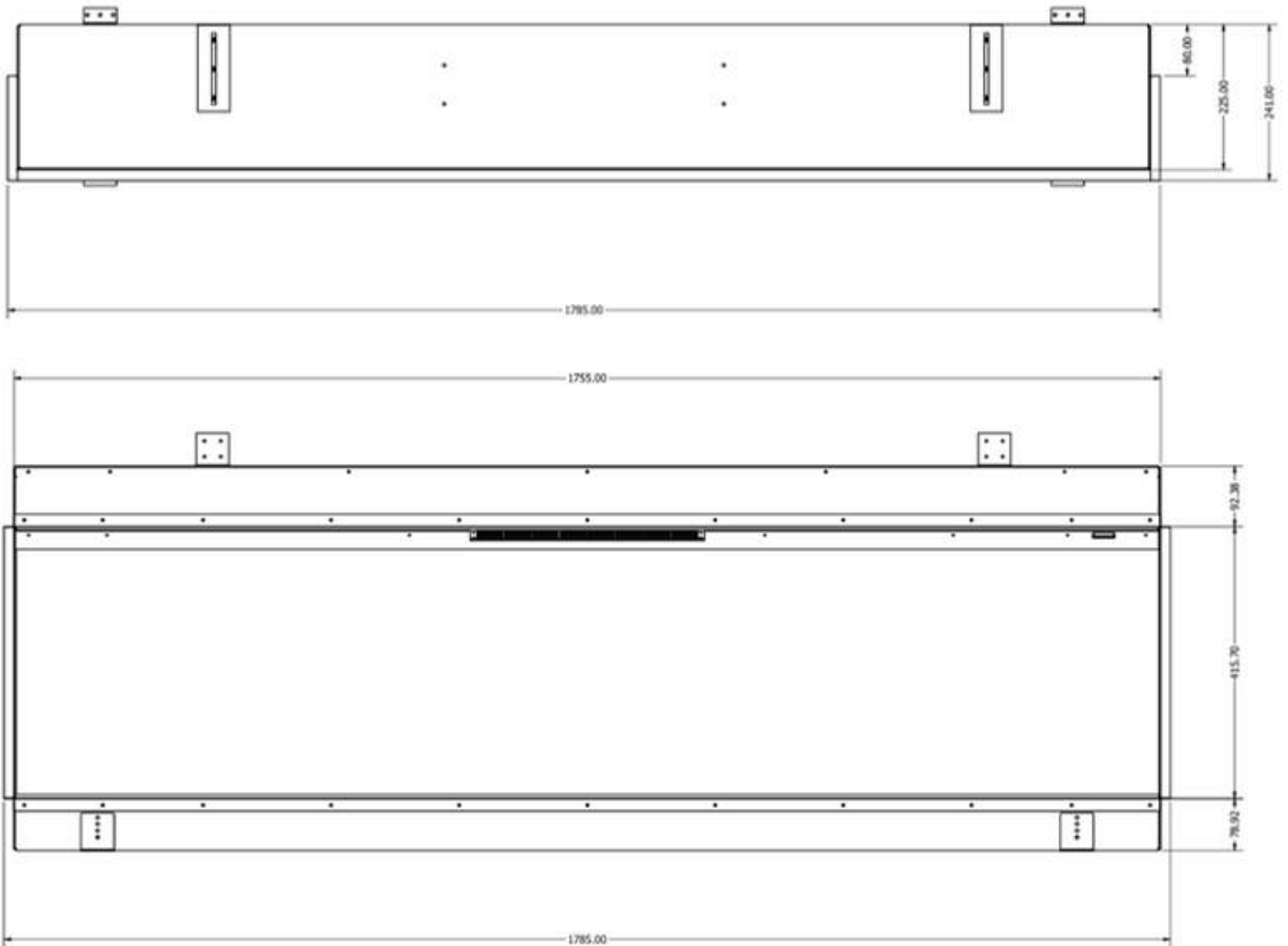



*Beautiful Warmth*

1 Evonic House, Clifford Park, Clifford Lane,  
Stratford-upon-Avon, Warwickshire, CV37 8HW  
TEL: 01789 263868 | FAX: 01789 293080  
[www.aura-fires.co.uk](http://www.aura-fires.co.uk) | [sales@aura-fires.co.uk](mailto:sales@aura-fires.co.uk)

